

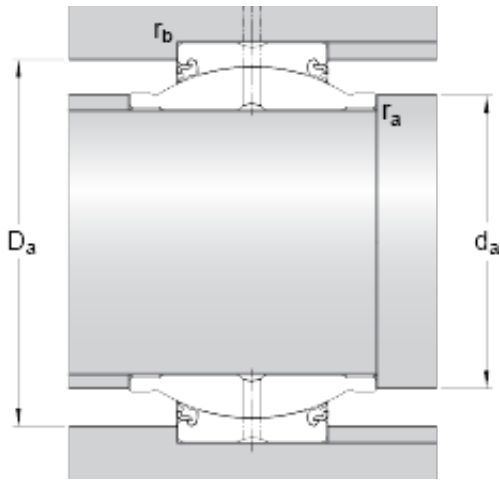

SNR BEARING CORP.OF AMERICA



60 mm x 90 mm x 54 mm skf GEM 60 ES-2LS Radial spherical plain bearings

Bearing No. GEM 60 ES-2LS

GEM 60 ES-2LS Bearing 2D drawings and 3D CAD models

Lubricant	Regular relubrication – grease
Design (sliding contact surface combination)	Steel/steel
Sealing solution	Triple-lip seals
d	60 mm
D	90 mm
B	54 mm
C	36 mm
	3 °
d _k	80 mm
d ₁	68 mm
b	6.2 mm
b ₁	6.2 mm
M	4 mm
r ₁ min.	0.6 mm
r ₂ min.	1 mm
d _a min.	65.4 mm
d _a max.	68 mm
D _a min.	79.7 mm
D _a max.	84.2 mm
r _a max.	0.6 mm
r _b max.	1 mm
Basic dynamic load rating C	245 kN
Basic static load rating C ₀	1220 kN
Specific dynamic load factor	100 N/mm ²



SNR BEARING CORP.OF AMERICA

K	
Specific static load factor K_0	500 N/mm ²
Material constant K_M	330
Mass plain bearing	1.15 kg