

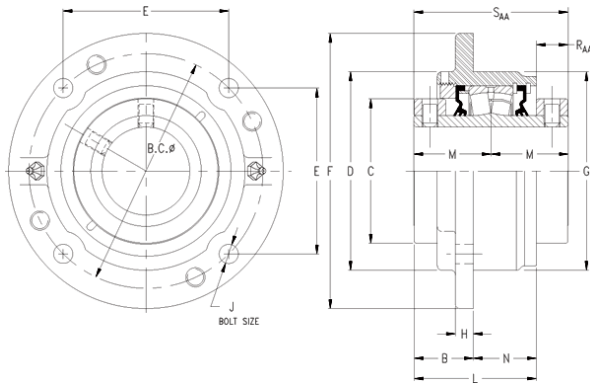

SNR BEARING CORP.OF AMERICA



timken QAACW20A315S Solid Block/Spherical Roller Bearing Housed Units-Double Concentric Piloted Flange Cartridge

Bearing No. QAACW20A315S

QAACW20A315S Bearing 2D drawings and 3D CAD models

Engineering Group	Mounted Bearing
Shaft Size	3-15/16 in
Shaft Size Type	Imperial
Full Timken Part Number	QAACW20A315SB
Locking Style	Double Concentric
Weight	43 lb
Housing Style	Piloted Flange Cartridge
UPC Code	0883450018005
Dimension BC	9.38 in
Dimension C	6.0000 in
Dimension E	6.63 in
Dimension B Fix	2.58 in
Dimension B Exp	2.66 in
Dimension F	10.88 in
Dimension D	8.13 in
Dimension H	1.00 in
Dimension J (Bolt Size)	0.75 in
Dimension M	2.97 in
Dimension G	8.125 in
Dimension L Exp	4.94 in
Dimension L Fix	4.86 in
Dimension N	2.28 in
Dimension RAA	1.19 in
Dimension SAA	5.94 in
C0 - Static Load	113000 lb



SNR BEARING CORP.OF AMERICA

C - Dynamic Load (Basic)	97700 lb
e - Geometry Factor	0.24
Y1 - Geometry Factor	2.85
Y2 - Geometry Factor	4.24
Oil Lubrication - M/N Seal	1200 rpm
Oil Lubrication - T Seal	2000 rpm
Oil Lubrication - B/C/O Seal	900 rpm
Grease Lubrication - M/N Seal	1200 rpm
Grease Lubrication - T Seal	1600 rpm
Grease Lubrication - B/C/O Seal	900 rpm
Float	0.083 in
Shaft Tolerance	0.0030 in
Eng Internal Radial Clearance - Min	0.0030
Eng Internal Radial Clearance - Max	0.0047
Pre Install Clearance Min	0.0030 in
Pre Install Clearance Max	0.0047 in