

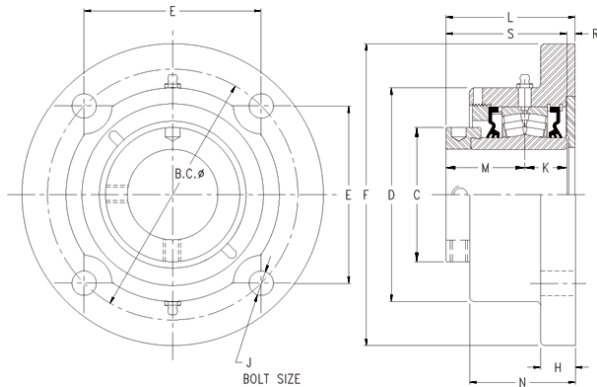

# SNR BEARING CORP.OF AMERICA



## timken QMFY13J065S Solid Block/Spherical Roller Bearing Housed Units-Eccentric Round Flange Block

Bearing No. QMFY13J065S

QMFY13J065S Bearing 2D drawings and 3D CAD models

Engineering Group	Mounted Bearing
Shaft Size	65 mm
Shaft Size Type	Metric
Full Timken Part Number	QMFY13J065SB
Locking Style	Eccentric
Weight	19 lb
Housing Style	Round Flange
UPC Code	0883450073226
Dimension BC	6.75 in
Dimension C	3.620 in
Dimension D	5.75 in
Dimension E	4.77 in
Dimension F	8.13 in
Dimension H	0.94 in
Dimension J (Bolt Size)	0.625 in
Dimension K	1.24 in
Dimension L Exp	3.56 in
Dimension L Fix	3.47 in
Dimension M	2.13 in
Dimension N	2.850 in
Dimension R	0.09 in
Dimension S	3.37 in
C0 - Static Load	48600 lb
C - Dynamic Load (Basic)	46400 lb
e - Geometry Factor	0.24



## SNR BEARING CORP.OF AMERICA

Y1 - Geometry Factor	2.79
Y2 - Geometry Factor	4.15
Oil Lubrication - M/N Seal	1800 rpm
Oil Lubrication - T Seal	3200 rpm
Oil Lubrication - B/C/O Seal	1500 rpm
Grease Lubrication - M/N Seal	1800 rpm
Grease Lubrication - T Seal	2800 rpm
Grease Lubrication - B/C/O Seal	1500 rpm
Float	0.083 in
Shaft Tolerance	0.0015 in
Eng Internal Radial Clearance - Min	0.0016
Eng Internal Radial Clearance - Max	0.0026
Pre Install Clearance Min	0.040 mm
Pre Install Clearance Max	0.065 mm